

NE522

High-Speed Dual-Differential Comparator/Sense Amp

Features

- 15 ns Maximum Guaranteed Propagation Delay
- 20 μ A Maximum Input Bias Current
- TTL-Compatible Strokes and Outputs
- Large Common-Mode Input Voltage Range
- Operates from Standard Supply Voltages

Applications

- MOS Memory Sense Amp
- A-to-D Conversion
- High-Speed Line Receiver

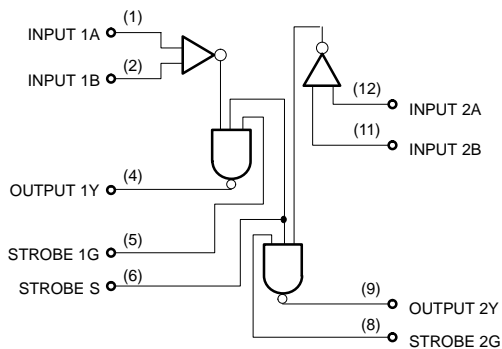

Figure 1. Block Diagram

LOGIC FUNCTION TABLE

V_{ID} (A ⁺ , B ⁻)	STRS	STRG	Output Transistor
$< -V_{OS}$	H	H	ON
$-V_{OS} < V_{ID} < V_{OS}$	H	H	Undefined
$> V_{OS}$	H	H	OFF
X	L	X	OFF
X	X	L	OFF



ON Semiconductor®

<http://onsemi.com>

MARKING DIAGRAMS

SOIC-14
D SUFFIX
CASE 751A

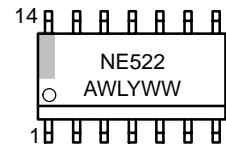
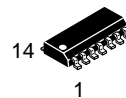

PDIP-14
N SUFFIX
CASE 646

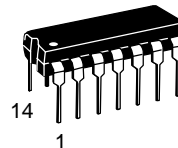

A = Assembly Location
WL = Wafer Lot
YY, Y = Year
WW = Work Week

PIN CONNECTIONS

D, N Packages

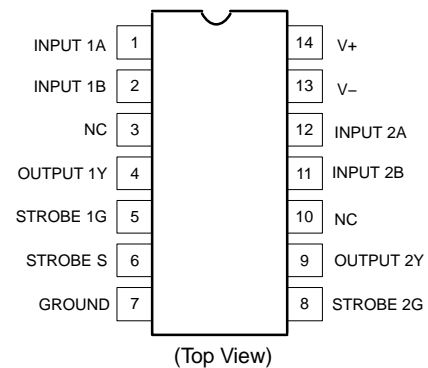

ORDERING INFORMATION

See detailed ordering and shipping information in the package dimensions section on page 5 of this data sheet.

NE522

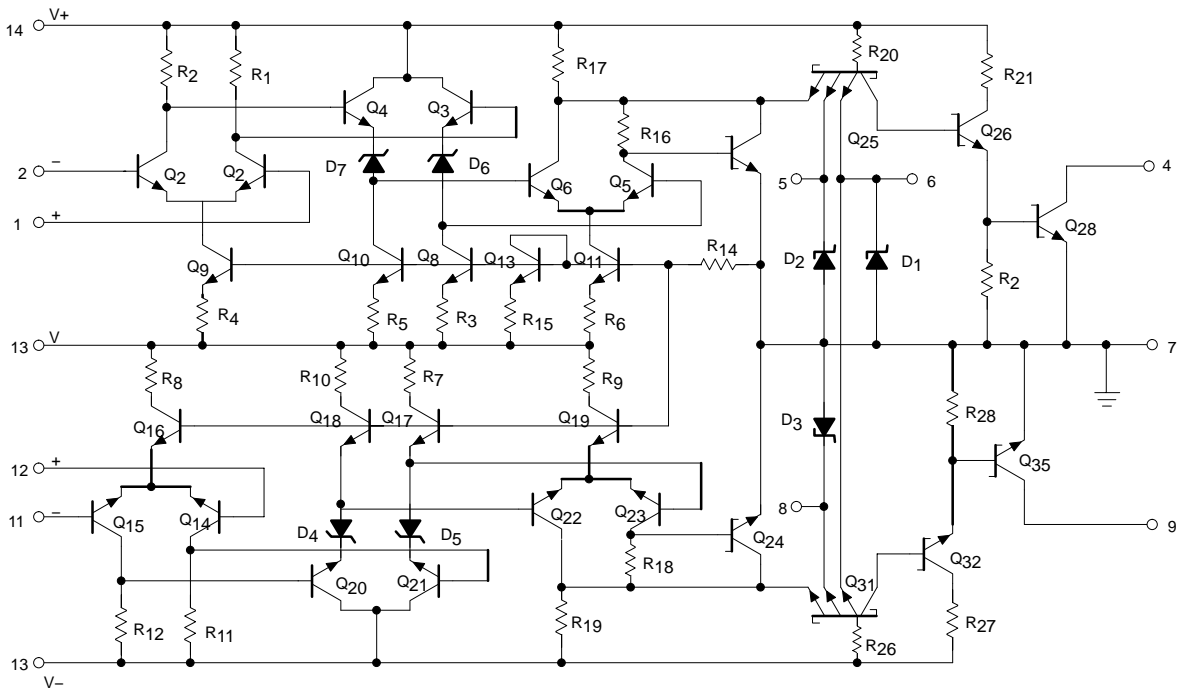

Figure 2. Equivalent Schematic

MAXIMUM RATINGS

Rating	Symbol	Value	Unit
Single Supply Voltage Positive Negative	V+ V-	+7.0 -7.0	V
Differential Input Voltage	V_{IDR}	± 6.0	V
Input Voltage Common-Mode Strobe/Gate	V_{IN}	± 5.0 +5.25	V
Power Dissipation	P_D	600	mW
Thermal Resistance, Junction-to-Ambient	$R_{\theta JA}$	100 145	$^{\circ}C/W$
	N Package D Package		
Operating Temperature Range	T_{amb}	0 to 70	$^{\circ}C$
Operating Junction Temperature	T_J	150	$^{\circ}C$
Storage Temperature Range	T_{stg}	-65 to +150	$^{\circ}C$
Lead Soldering Temperature (10 sec max)	T_{slid}	+230	$^{\circ}C$

Maximum ratings are those values beyond which device damage can occur. Maximum ratings applied to the device are individual stress limit values (not normal operating conditions) and are not valid simultaneously. If these limits are exceeded, device functional operation is not implied, damage may occur and reliability may be affected.

NE522

DC ELECTRICAL CHARACTERISTICS ($V_{\pm} = \pm 5.0 \text{ V} \pm 5\%$; $T_{\text{amb}} = 0 \text{ }^{\circ}\text{C}$ to $+70 \text{ }^{\circ}\text{C}$, unless otherwise noted.)

Characteristic	Symbol	Test Conditions	Min	Typ	Max	Unit
Input Offset Voltage At 25°C Overtemperature Range	V_{OS}	$V_{+} = +4.75 \text{ V}$; $V_{-} = -4.75 \text{ V}$	– –	6.0 –	7.5 10	mV
Input Bias Current At 25°C Overtemperature Range	I_{BIAS}	$V_{+} = +5.25 \text{ V}$; $V_{-} = -5.25 \text{ V}$	– –	7.5 –	20 40	μA
Input Offset Current At 25°C Overtemperature Range	I_{OS}	$V_{+} = +5.25 \text{ V}$; $V_{-} = -5.25 \text{ V}$	– –	1.0 –	5.0 12	μA
Common-Mode Voltage Range	V_{CM}	$V_{+} = +4.75 \text{ V}$; $V_{-} = -4.75 \text{ V}$	–3.0	–	+3.0	V
LOW-Level Input Voltage At 25°C Overtemperature Range	V_{IL}	–	– –	– –	0.8 0.7	V
High Level Temperature	V_{IH}	–	2.0	–	–	V
HIGH-Level Input Current 1G or 2G Strobe Common Strobe S	I_{IH}	$V_{+} = +5.25 \text{ V}$; $V_{-} = -5.25 \text{ V}$; $V_{\text{IH}} = 2.7 \text{ V}$	– –	– –	50 100	μA
LOW-Level Input Current 1G or 2G Strobe Common Strobe S	I_{IL}	$V_{\text{IL}} = 0.5 \text{ V}$	– –	– –	–2.0 –4.0	mA
LOW-Level Output Voltage	V_{OL}	$V_{+} = +5.25 \text{ V}$; $V_{-} = -5.25 \text{ V}$; $V_{\text{I(S)}} = 2.0 \text{ V}$; $I_{\text{LOAD}} = 20 \text{ mA}$	–	–	0.5	V
HIGH-Level Output Current	I_{OH}	$V_{+} = +4.75 \text{ V}$; $V_{-} = -4.75 \text{ V}$; $V_{\text{OH}} = 5.25 \text{ V}$	–	–	250	μA
Supply Voltage Positive Negative	V_{+} V_{-}	–	4.75 –4.75	5.0 –5.0	5.25 –5.25	V
Supply Current Positive Negative	$I_{\text{CC+}}$ $I_{\text{CC-}}$	$V_{+} = +5.25 \text{ V}$; $V_{-} = -5.25 \text{ V}$; $T_{\text{amb}} = 25^{\circ}\text{C}$	– –	27 –15	35 –28	mA

AC ELECTRICAL CHARACTERISTICS ($T_{\text{amb}} = 25^{\circ}\text{C}$; $R_{\text{L}} = 280 \text{ } \Omega$; $C_{\text{L}} = 15 \text{ pF}$, unless otherwise noted.)

Characteristic	Symbol	From Input	To Output	Min	Typ	Max	Unit
Input Resistance	I_{R}	–	–	–	4.0	–	$\text{k}\Omega$
Input Capacitance	I_{C}	–	–	–	3.0	–	pF

Large-signal switching speed

Propagation Delay Low to High (Note 1)	$t_{\text{PLH(D)}}$	Amp	Output	–	10	15	ns
High to Low (Note 1)	$t_{\text{PHL(D)}}$	Amp	Output	–	8.0	12	
Low to High (Note 2)	$t_{\text{PLH(S)}}$	Strobe	Output	–	6.0	13	
High to Low (Note 2)	$t_{\text{PHL(S)}}$	Strobe	Output	–	5.0	9.0	
Maximum Operating Frequency	I_{MAX}	–	–	25	35	–	MHz

1. Response time measured from 0 V point of $+100 \text{ mV}_{\text{P-P}}$ 10 MHz square wave to the 1.5 V point of the output.
2. Response time measured from 1.5 V point of the input to 1.5 V point of the output.

TYPICAL PERFORMANCE CHARACTERISTICS

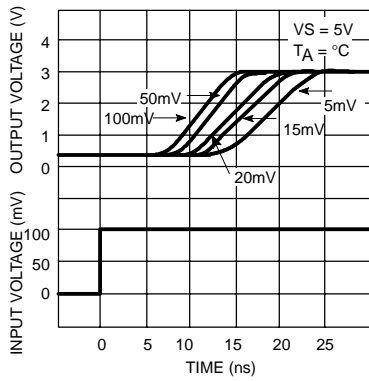

Figure 3. Response Time for Various Input Overdrives

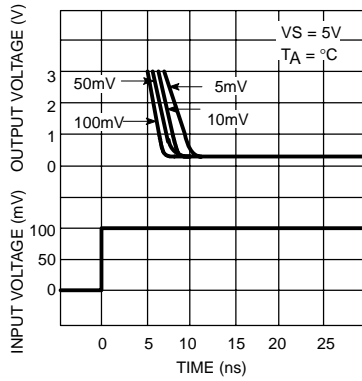

Figure 4. Response Time for Various Input Overdrives

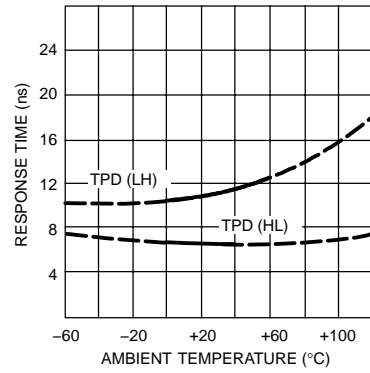

Figure 5. Response Time vs. Temperature

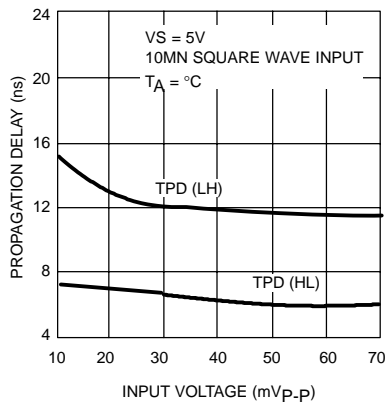

Figure 6. Propagation Delay for Various Input Voltages

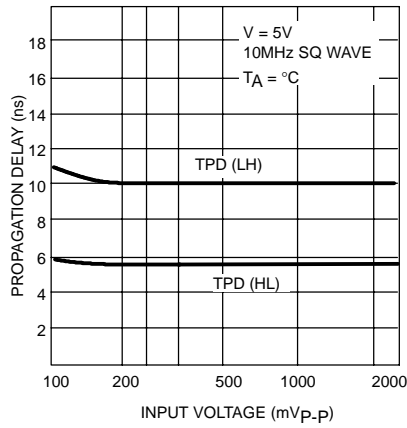

Figure 7. Propagation Delay for Various Input Voltages

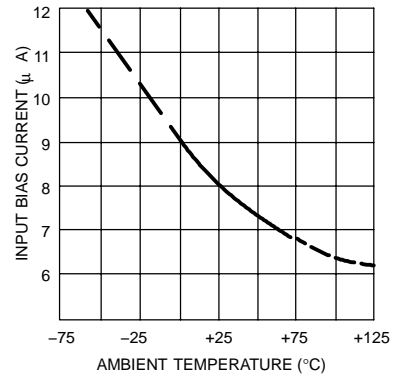

Figure 8. Input Bias Current vs. Ambient Temperature

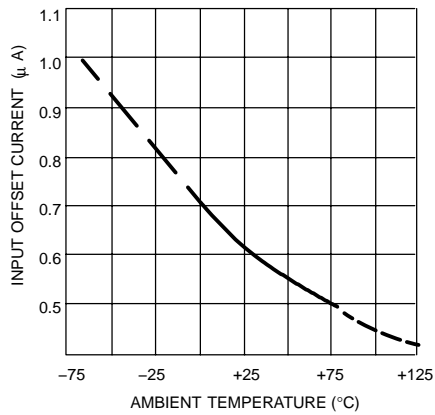

Figure 9. Input Offset Current vs. Ambient Temperature

NE522

ORDERING INFORMATION

Device	Description	Temperature Range	Shipping†
NE522D	14-Pin Plastic SO	0 to +70°C	55 Units/Rail
NE522DR2	14-Pin Plastic SO	0 to +70°C	2500 Tape & Reel
NE522N	14-Pin Plastic DIP	0 to +70°C	25 Units/Rail

†For information on tape and reel specifications, including part orientation and tape sizes, please refer to our Tape and Reel Packaging Specification Brochure, BRD8011/D.

NE522

PACKAGE DIMENSIONS

SOIC-14
D SUFFIX
CASE 751A-03
ISSUE G

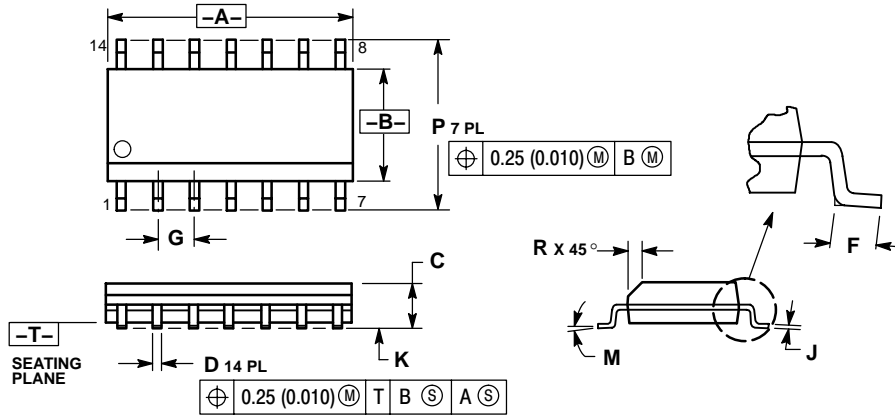

NOTES:

1. DIMENSIONING AND TOLERANCING PER ANSI Y14.5M, 1982.
2. CONTROLLING DIMENSION: MILLIMETER.
3. DIMENSIONS A AND B DO NOT INCLUDE MOLD PROTRUSION.
4. MAXIMUM MOLD PROTRUSION 0.15 (0.006) PER SIDE.
5. DIMENSION D DOES NOT INCLUDE DAMBAR PROTRUSION. ALLOWABLE DAMBAR PROTRUSION SHALL BE 0.127 (0.005) TOTAL IN EXCESS OF THE D DIMENSION AT MAXIMUM MATERIAL CONDITION.

DIM	MILLIMETERS		INCHES	
	MIN	MAX	MIN	MAX
A	8.55	8.75	0.337	0.344
B	3.80	4.00	0.150	0.157
C	1.35	1.75	0.054	0.068
D	0.35	0.49	0.014	0.019
F	0.40	1.25	0.016	0.049
G	1.27 BSC		0.050 BSC	
J	0.19	0.25	0.008	0.009
K	0.10	0.25	0.004	0.009
M	0°	7°	0°	7°
P	5.80	6.20	0.228	0.244
R	0.25	0.50	0.010	0.019

NE522

PACKAGE DIMENSIONS

PDIP-14
N SUFFIX
CASE 646-06
ISSUE M

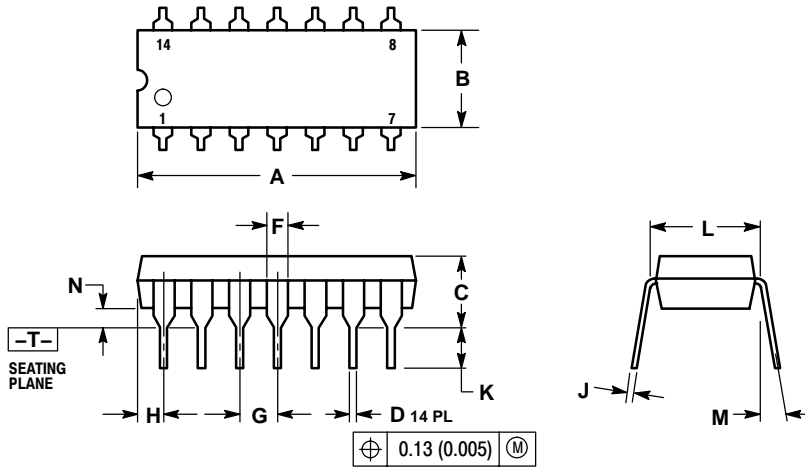

NOTES:

1. DIMENSIONING AND TOLERANCING PER ANSI Y14.5M, 1982.
2. CONTROLLING DIMENSION: INCH.
3. DIMENSION L TO CENTER OF LEADS WHEN FORMED PARALLEL.
4. DIMENSION B DOES NOT INCLUDE MOLD FLASH.
5. ROUNDED CORNERS OPTIONAL.

DIM	INCHES		MILLIMETERS	
	MIN	MAX	MIN	MAX
A	0.715	0.770	18.16	18.80
B	0.240	0.260	6.10	6.60
C	0.145	0.185	3.69	4.69
D	0.015	0.021	0.38	0.53
F	0.040	0.070	1.02	1.78
G	0.100 BSC		2.54 BSC	
H	0.052	0.095	1.32	2.41
J	0.008	0.015	0.20	0.38
K	0.115	0.135	2.92	3.43
L	0.290	0.310	7.37	7.87
M	----	10°	----	10°
N	0.015	0.039	0.38	1.01

ON Semiconductor and  are registered trademarks of Semiconductor Components Industries, LLC (SCILLC). SCILLC reserves the right to make changes without further notice to any products herein. SCILLC makes no warranty, representation or guarantee regarding the suitability of its products for any particular purpose, nor does SCILLC assume any liability arising out of the application or use of any product or circuit, and specifically disclaims any and all liability, including without limitation special, consequential or incidental damages. "Typical" parameters which may be provided in SCILLC data sheets and/or specifications can and do vary in different applications and actual performance may vary over time. All operating parameters, including "Typicals" must be validated for each customer application by customer's technical experts. SCILLC does not convey any license under its patent rights nor the rights of others. SCILLC products are not designed, intended, or authorized for use as components in systems intended for surgical implant into the body, or other applications intended to support or sustain life, or for any other application in which the failure of the SCILLC product could create a situation where personal injury or death may occur. Should Buyer purchase or use SCILLC products for any such unintended or unauthorized application, Buyer shall indemnify and hold SCILLC and its officers, employees, subsidiaries, affiliates, and distributors harmless against all claims, costs, damages, and expenses, and reasonable attorney fees arising out of, directly or indirectly, any claim of personal injury or death associated with such unintended or unauthorized use, even if such claim alleges that SCILLC was negligent regarding the design or manufacture of the part. SCILLC is an Equal Opportunity/Affirmative Action Employer. This literature is subject to all applicable copyright laws and is not for resale in any manner.

PUBLICATION ORDERING INFORMATION

LITERATURE FULFILLMENT:

Literature Distribution Center for ON Semiconductor
P.O. Box 61312, Phoenix, Arizona 85082-1312 USA
Phone: 480-829-7710 or 800-344-3860 Toll Free USA/Canada
Fax: 480-829-7709 or 800-344-3867 Toll Free USA/Canada
Email: orderlit@onsemi.com

N. American Technical Support: 800-282-9855 Toll Free
USA/Canada

Japan: ON Semiconductor, Japan Customer Focus Center
2-9-1 Kamimeguro, Meguro-ku, Tokyo, Japan 153-0051
Phone: 81-3-5773-3850

ON Semiconductor Website: <http://onsemi.com>

Order Literature: <http://www.onsemi.com/litorder>

For additional information, please contact your
local Sales Representative.